

Revolutionize your lifestyle with water.

Moisturize your skin,
make your hair shiny!



First manufacturer to use
a twin cartridge system!

MINERAL ION WATER

ANESPA

Mineral Ion Water Activator

Patent/Trademark registration applied

Feels like being in Hot spring Resort

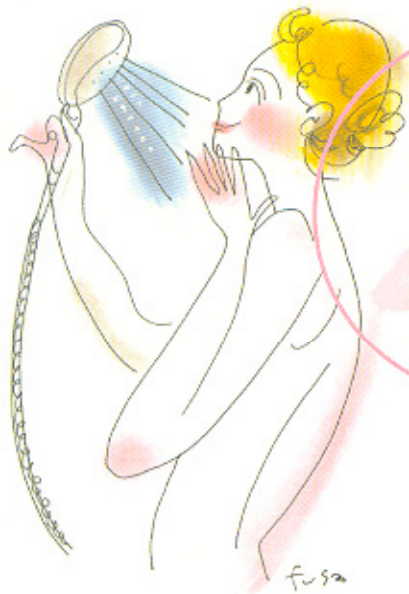

Skin moisturizer

Feel fresh with youthful skin.

Have a more youthful complexion and supple skin.

These are the benefits of healthy mineral ion water.

It gives an effective massage while taking a bath everyday and makes the skin beautiful.

It gives me have a lasting beauty.



Shiny hair

Everybody likes to have shiny hair.

When you shake your hair, there is a halo, which dazzles the passer-by instantly

You get a pleasurable feeling when you touch your hair.

You feel great throughout the day because of your beautiful hair.

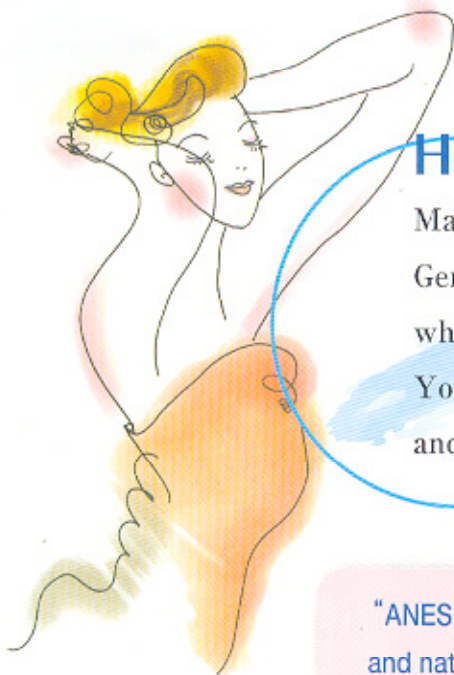

Hot spring resort feeling

Makes you feel relaxed, just like a hot spring bath.

Gentle effect of negative-ions relaxes your mind and body which is very refreshing.

You feel relaxed over a long period of time and have a new vigor.

"ANESPA" Hot spring enhances health and beauty due to the Hot spring effect and natural minerals. "New Hygienic Bath" is recommended not only for people with healthy skin but also for those who face skin problems or have delicate skin.

everyday as mineral ion water has a soothing effect

Ensures removal of almost 100% of residual chlorine.

Chlorine disinfects the tap water. But there is also a threat that it may generate toxic substances like Trihalomethane, which is one of the carcinogens. Approximately 30%~ 90% of these toxic substances are absorbed by the body through the skin while taking a steam bath.

The research in America shows that "The quantity of toxic substances absorbed during 15 minute bath or shower is equivalent to drinking 1 liter of contaminated water".

Further, the temperature of 40°C, at which Chlorine is easily absorbed by the skin, is the most suitable water temperature for taking a bath!

"ANESPA" makes hot water suitable for baths by completely removing residual Chlorine and bacteria from the tap water using a purification system of the cartridge.



"ANESPA" contains a blend of natural Hot spring ingredients and minerals. It gives a unique feeling of enjoying Radium Hot spring, generated by mineral ion water, which enhances the relaxation effects.

The cartridge of "ANESPA" contains only carefully selected ingredients that are good for the skin. An example would be, Tufa, which is taken from the Futamata Radium Hot spring of Hokkaido. You can enjoy the benefits of a Hot spring along with natural minerals, which gives the body a warm, comfortable feeling.

Moreover, the relaxation effect is remarkable because of MIC stone that generates activated, mildly alkaline water, which is good for the skin, the Power stone, which generates strong negative-ions and also because of the effect of Chikutan ceramic. Experience the relaxation while taking a bath.



It is effective for the problems such as aging, de-pigmentation and freckles. It also protects the delicate skin from excessive stimulation by water.

Chlorine is the greatest enemy of the skin. When the skin absorbs it, it forms Chlorine oxides combining with fat, which leads to aging, de-pigmentation and freckles.

A hot water bath with "ANESPA" is suggested to the persons who are conscious about their health, persons with sensitive skin and also for the babies.

Purifying tap water to obtain mineral ion water

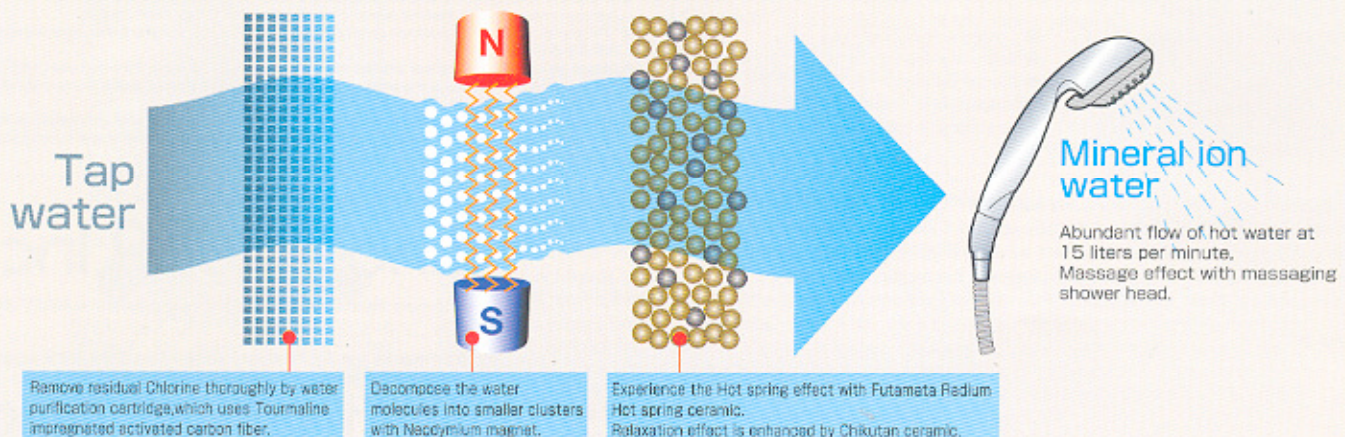

...ing effect on your skin and hair.

Protects the glowing hair from Chlorine damage.

The residual Chlorine causes hair damage like loss of hair, split ends or change of color.

The main reason is that the hydrolyzed proteins combined with Chlorine and take away moisture from the hair.

Further, residual Chlorine becomes more active in hot water and damages the hair.

Mineral ion water generated from "ANESPA" is most suitable for beautiful hair.

Moreover, negative-ions generated by Power stone are very effective for the healthy hair. You can try it for hair damaged because of perming and the dyeing of hair.

The damage situation of hair

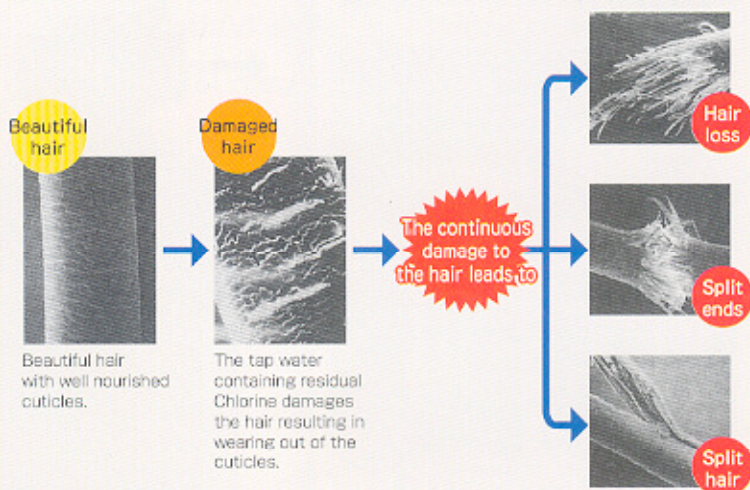

Comfortable with abundant hot water quantity supplied to the bathtub.

After all, the best way of relaxation is "Taking hot water bath leisurely".

You can take a bath after 15~20 minutes as "ANESPA" supplies water at a rate of 15 liters per minute.

**Average capacity of bathtub
About 260~300ℓ**



Mini guide of Futamata Radium Hot spring, Hokkaido

Radium (Radon) Hot spring

The gushing out spring has Radium containing radioactive ore, which emits low-level nuclear radiations (alpha rays). Radium is in a solid state and it is an element that can break down to Radon. Radon is a stable gas that can be dissolved in water. It enters the body through breathing and also through skin.

The strong ionization (bioactive action) promotes the metabolism, improves natural healing power and normalizes the autonomic nervous system.

Benefits

Effective for prickly heat, dry skin, poor circulation, eczema, frostbite, bruise, sprain, stiffness in the shoulder, nerve pain, rheumatism, recovery from fatigue, hemorrhoid, lower back pain, insomnia and atopic dermatitis

Properties of Hot spring

Contains Radium, Carbonic acid and Calcium
Includes effective minerals in large quantities

Antibacterial activity of Calcium ion

Controls the growth of Staphylococcus aureus bacteria and reduces the symptoms of atopic dermatitis (irritation/itching).

Effect of carbonic acid

When Carbonic acid is absorbed in the body, the pH of the blood decreases by 0.10.2. It dilates the blood capillaries in the body and increases blood flow to the skin which results in the recovery from fatigue, prevention of disease, and enhances the healing process.

Tufa

It is a mineral stone formed by depositing crystals of Calcium Carbonate, which is an ingredient of Hot spring.

The Aragonite (dissolvable in water) of calcium is the main ingredient. The calcium is absorbed in the body by percolation through the skin. The mineral content improves the overall physical condition and also enhances heat regulation, antibacterial activity and calming effect. Weak alkaline water quality of pH 6.8~7.5. Contains Radium (5.47 Mache)

Tufa ingredients

Calcium Carbonate	95.75%
Sulfuric acid	1.29%
Iron	0.93%
Silicic acid	0.67%
Aluminum	0.51%
Chlorine	0.39%
Magnesium	0.18%
Manganese	0.16%
Water	0.12%
pH	6.8~7.5



Hokkaido Yamaguchi
Oshamanbe
Omine 30

Futamata Radium Hot spring



Diameter 9cm (Base diameter is 12cm).

It is a model having a slim body with a powerful design.

Standard accessories are a shower hose, water supply hose, hot water pipe, and massaging shower head of stainless steel, and is resistant to rust and dirt.

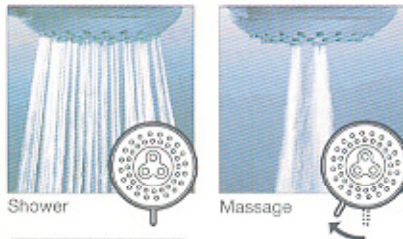
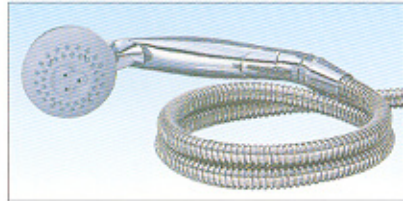

Water dimmer (water saver)
You can effectively save water by fixing it at the lower part of the shower head.

Grey	(35% water saving)
Green	(50% water saving)

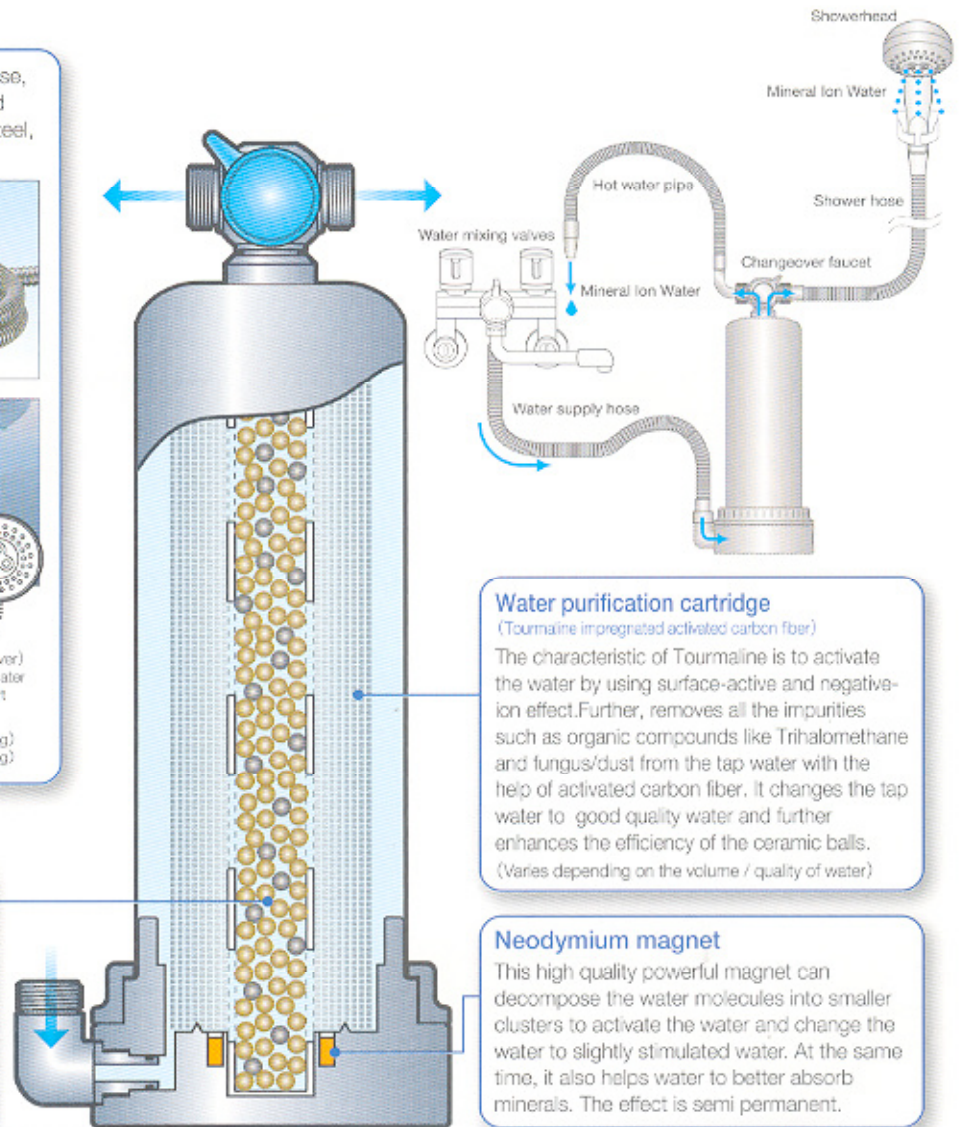

Water purification cartridge

(Tourmaline impregnated activated carbon fiber)

The characteristic of Tourmaline is to activate the water by using surface-active and negative-ion effect. Further, removes all the impurities such as organic compounds like Trihalomethane and fungus/dust from the tap water with the help of activated carbon fiber. It changes the tap water to good quality water and further enhances the efficiency of the ceramic balls. (Varies depending on the volume / quality of water)

Ceramic cartridge

The cartridge has a layer of ceramic filling. The layer of ceramic filling is approximately 3 times the size as compared to conventional product. Ceramic balls of both Futamata Radium Hot spring and Chikutan are comfortably filled in a single cartridge. (Refer the following for details)

Neodymium magnet

This high quality powerful magnet can decompose the water molecules into smaller clusters to activate the water and change the water to slightly stimulated water. At the same time, it also helps water to better absorb minerals. The effect is semi permanent.

Bringing together a high level of natural strengths!



First manufacturer to use it a twin cartridge

Mineral ion water obtained from [Water purifying cartridge] + [Ceramic cartridge] protects your skin and hair and gives a relaxation effect.

Special Futamata Radium Hot spring ceramic ball made from Tufa, MIC stone and Power stone

Tufa is extracted from Futamata Radium Hot spring in Hokkaido, which is famous for Hot spring. Tufa is made by precipitating Calcium Carbonate and hardening it. The main ingredient is Radium Calcium Carbonate. Hence, metabolism is accelerated and mild Hot spring effect is obtained by eluting the calcium. The ceramic for "ANESPA" is a combination of MIC stone, which is observed to have a water purifying quality / regulating action of harmful contaminants in water and a Power stone that naturally has abundant negative-ions and the highest level of far-infrared radiant energy and is packed in the cartridge.

Chikutan Ceramic ball

Generates strong negative-ions that give a relaxing effect. Further, it cleans the air and prevents oxidation. Heating/thermal effect is obtained from far-infrared radiation.

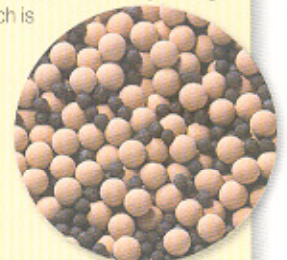

• Tufa

It is a mineral stone formed by depositing crystals of Calcium Carbonate, which is an ingredient of Hot spring. Mild Hot spring effect, and is mainly due to Calcium Carbonate and minerals, is obtained.

• Power stone

Naturally activated Power stone, which generates a high level of far-infrared radiant energy and negative-ions naturally is now in focus. Especially because it releases 30 times more negative-ions than the natural Tourmaline stone.

• MIC stone

MIC stone is rich in minerals as it is made up of more than 25,000 different minerals. It purifies the water by absorbing toxic substances and regulates the water quality.

No special installation required. Can be installed on most of the water mixing valves.

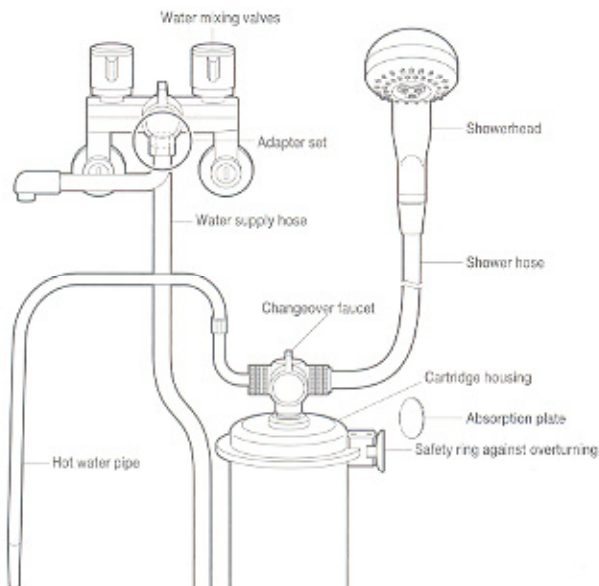

● Installation example

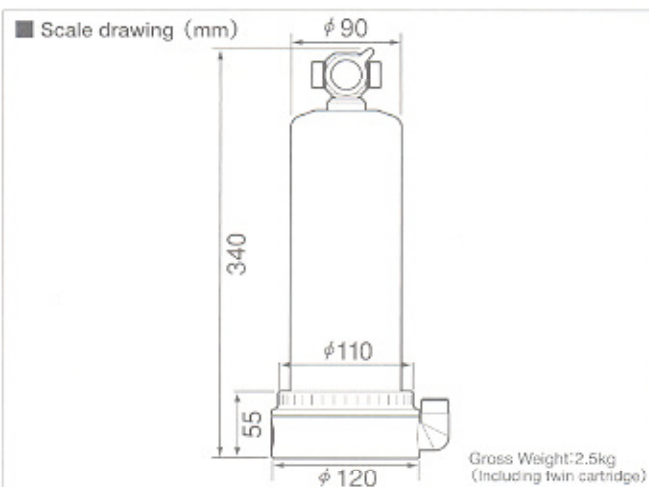
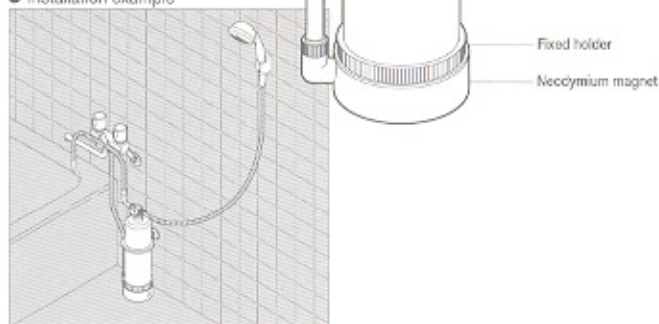

■ Installation examples on the water mixing valve (installation requires fittings and accessories depend on the place)

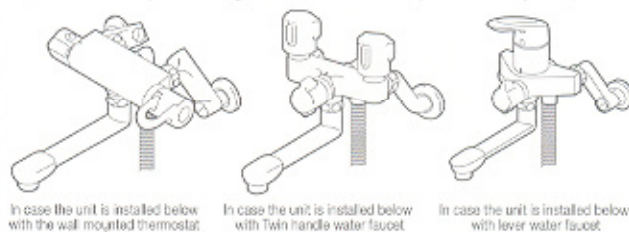

[Sales price]

■ Unit price US\$ 2,390.00 (excluding installation charges / taxes) (including standard accessories)

[Items sold separately]

■ Twin cartridge US\$ 350.00 (excl. tax)
 ■ Shower hose (200cm) US\$ 40.00 (excl. tax)
 ■ Water supply hose (200cm) US\$ 50.00 (excl. tax)
 ■ Hot water pipe (100cm) US\$ 40.00 (excl. tax)

Standard specifications

MODEL NAME-NUMBER	ANESPA ANSP-01
Dimensions of the main body	Height 340mm Diameter 120mm (excluding water source connection)
Target substance to be eliminated	Residual Chlorine
Filtrate	Residual Chlorine (1mg/l, 40°C) 250~300 l (varies according to the volume and quality of water)
Filtering Medium	Activated carbon fiber
Filtration flow	10 l/minute (0.1 MPa, 40°C) Maximum 15 l/minute
Working pressure	0.05~0.5MPa
Maximum operating temperature	60°C
Period for cartridge replacement	About 1 year (the replacement may be required earlier depending on the quality of water and its usage)
Material	Stainless Steel SUS304, Chrome plated ABS resin, PP, Bc

Standard accessories

- Hot water pipe (length 48cm)
- Water supply hose (length 120cm)
- Shower hose (length 100cm)
- Showerhead
- Twin cartridge (water purification cartridge / ceramic cartridge)
- Cartridge replacement seal (1)
- Safety ring against overturning (with suction cup)
- Suction plate (1)
- Adapter set
- Water dimmer (Water saver)

SAFETY PRECAUTIONS

For your own safety, be sure to observe the following precautions

CAUTION

- Please read the Operation Manual carefully, and then use according to instructions.
- Do not use this product anywhere other than hot water for the bathtub and shower.
- Use the hot water as per approved standards of water-purity.
- Keep the water temperature below 60°C.
- Do not connect it to a instant water heater or a running water heater.
- Replace the filter frequently in the regions where iron and calcium contents in water are high.
- Do not fix instructions such as "do not supply hot water to bathtub by shower" on the hot water vessel.
- Do not use this when water supply is under repairs and when there is a supply of red water.

- The unit price of the merchandise described in this catalog do not include sales tax, transportation charges, fees for repairs or installation and replacement charges.
- The specifications or appearance of the product are subject to manufacturer's improvements without prior notice.
- Please be aware of that actual product may differ slightly in color, etc from that seen in print.
- For more information about the product, please inquire with the sales dealer in your district or area.
- Every product has an accompanying warranty card, which shall be filled in and issued by the Representative Sales Firm. Please check the contents and keep it in safe place for later use during the period of warranty.

A system for the periodic replacement of the cartridge is recommended.

The abilities of ANESPA cannot be fully utilized if a cartridge is used whose life is nearly over or is in use for a long time. We have a system wherein a Spare cartridge can be purchased in advance along with the product. There is no need in keeping the replacement time in mind and worry about the life of the product. When the replacement is due, you will definitely receive the Spare cartridge from us.

Dealer

Exclusive Distributor

Enagic USA, Inc.

1515 West 190th Street, Suite 535, Gardena, California 90248 USA
 TEL : 310-532-9000 FAX : 310-532-9010

● For inquiries regarding installation, maintenance and operation of product:
 Customer Support Center

Toll-Free 1-866-261-9500

Pre-recorded message on Saturdays, Sundays and Holidays